



LIFE SAFETY &amp; INCIDENT MANAGEMENT

# Intelligent Fire Alarm Systems

iO64, iO1000



## Overview

EDWARDS brand intelligent life safety systems offer the power of high-end intelligent processing in configurations that deliver uncomplicated solutions for small-to-mid-sized applications. With intelligent detection, electronic addressing, automatic device mapping, optional Ethernet® connectivity, and a full line of easily-configured option cards and modules, these flexible systems offer versatility that benefits building owners and contractors alike.

The iO64 provides one Class A or Class B intelligent device loop that supports up to 64 device addresses, and two Class B Notification Appliance Circuits (NACs). Optional Class A device wiring is available with the use of a module.

The iO1000 provides one Class A or Class B intelligent device loop that supports up to 250 device addresses. Loop controller modules may be added in combination to expand total system capacity in 250-point increments to up to 1,000 device addresses. The iO1000 panel includes four NACs that may be wired for either Class A or Class B operation.

The RZ116-2 module adds even more capacity to iO installations by adding up to 16 conventional device circuits and two additional notification appliance circuits. This makes them an ideal retrofit solution that can accommodate new intelligent detectors, as well as existing conventional devices.

iO Series supports a wide range of high-end features, including:

- Supports 10-Year Carbon Monoxide detectors
- R-Series remote annunciators
- SIGA-REL Releasing Modules
- Fully integrated CO detection using Signature Series detectors with or without audible signaling

## Features

- Auto-programming reduces installation time
- Supports Signature Series intelligent modules and detectors
- Combines the Signature intelligent releasing module with Signature multisensor detectors for reliable fire suppression
- Electronic addressing with automatic device mapping
- Optional Ethernet port (SA-ETH) for central station monitoring service, programming, diagnostics and a variety of system reports.
- Two programmable switches with LEDs and custom labeling
- Supports Genesis horn silence over two wires, and UL 1971-compliant strobe synchronization
- Optional multi-protocol Field Server Bridge for interface to third-party Building Management Systems.
- Ground fault detection by module
- Supports up to eight serial annunciators, (LCD, LED-only, and graphic interface)
- Can use existing wiring for most retrofit applications
- Upload/download remotely or locally
- Optional USB module for local printing or programming using the configuration utility on a technician's laptop.
- Two-level maintenance alert reporting
- Pre-alarm and alarm verification by point
- Adjustable detector sensitivity
- 4 x 20 character backlit LCD display
- Optional earthquake hardening; seismic Importance Factor 1.5
- Standalone operation
- Alarm ON command manually activates alarm condition
- Form C contacts for alarm and trouble, Form A for supervisory

## Application

The EDWARDS iO Series life safety systems are powerful intelligent solutions for small to mid-sized buildings. Advanced intelligent technology delivers the benefits of flexible system installation, while clean and easy-to-operate user interfaces make panel operation and system maintenance quick and intuitive.

### The smart choice

Signature Series electronic addressing eliminates the tedium of setting dip switches, and automatic device mapping ensures that each device resides on the system at its correct location. Meanwhile, innovative programming allows the designer to customize the system to precisely suit the needs of the building owner.

### Reliability you can count on

The inherent fault-tolerant characteristics of Analog/Addressable Technology boost the reliability of EDWARDS brand fire alarm systems. When combined with iO Series smoke and heat detectors, these systems deliver a level of dependability not previously available for small-to-mid-sized applications. All EDWARDS systems are built to exacting reliability benchmarks.

### Clear-cut remote annunciation

Remote annunciation is a strong suit of the iO Series fire alarm systems. Up to eight annunciators can be installed on a single system. Compatible annunciators include a range of LED and LCD models that provide zone or point annunciation, as well as common control capabilities. iO control panels also support graphic annunciation with optional RA Graphic Annunciator interface modules. Each interface provides common control and 32 LEDs.

### Flexibility built right in

Two fully-programmable front panel switch/LED combinations provide an added measure of flexibility. Their slide-in labels take the mystery out of custom applications, and present a clean, finished appearance.

## Programming and remote diagnostics

The EDWARDS iO Series life safety systems are simple to set up, yet offer advanced programming features that put these small building panels into a class of their own. The auto programming feature quickly gets the panel operational using factory default settings. Basic zone and point settings can be programmed through the front panel interface, so the system is up and running in no time.

For more advanced system configuration and correlation groups programming, iO Series systems interface to a PC running compatible iO-CU software. This option offers full system configuration in the familiar Windows® operating environment. Connection is made to a laptop through the panel's optional RS-232 communications port, which can also be used to connect a system printer.

Among the many innovative features of iO Series control panels is the optional network card. This module provides a standard 10/100 Base T Ethernet® network connection that permits access to the control panel from any remote location with the correct communications protocols. The connection can be used to download to the panel from the iO-CU, or upload and view system reports using the iO-CU.

Available system reports include: Correlation groups, Device details, Device maintenance, History, Internal status, System configuration, System status, Walk test, Dialer, and CO runtime.

### Perfect for retrofits

The EDWARDS iO Series control panels are particularly well-suited to retrofit applications. All connections are made over standard wiring – no shielded cable required. This means that in most situations existing wiring can be used to upgrade a legacy control panel to iO technology without the expense or disruption of rewiring the entire building. iO control panels also support the ingenious RZI16-2 Zone Module, which adds up to 16 conventional circuits and two NACs. This combination easily accommodates new intelligent detection alongside existing conventional circuits, making it a superior solution in the retrofit market.

### Scalable IP and Cellular Communications

Optional SA-ETH module supports IP connection to a central station's Sur-Gard receiver, meeting one of the methods of communication allowed by NFPA 72 as of the 2013 Edition. Several popular third-party IP/Cellular communicators have been tested with the iO control panels and are compatibility-listed to UL864. The IP/Cellular communicators meet NFPA72 2013 edition requirements for sole or secondary transmission paths. Using IP/Cellular communicators can reduce the cost of ownership by eliminating POTS lines. Please see the iO control panel compatibility documentation part number 3102353-EN for a full list of compatible communicators.

### Signals with a difference

iO system NACs are configurable to fully support the advanced signaling technology of the EDWARDS Genesis and Enhanced Integrity notification appliances. These devices offer precision synchronization of strobes to UL 1971 standards. For Genesis devices, enabling this feature allows horns to be silenced while strobes on the same two-wire circuit continue to flash until the panel is reset.

### A complete line of accessories

iO Series life safety systems are supported by a complete line of analog/addressable detectors, modules and related equipment. Consult the Ordering Information section for details.

## Dimensions

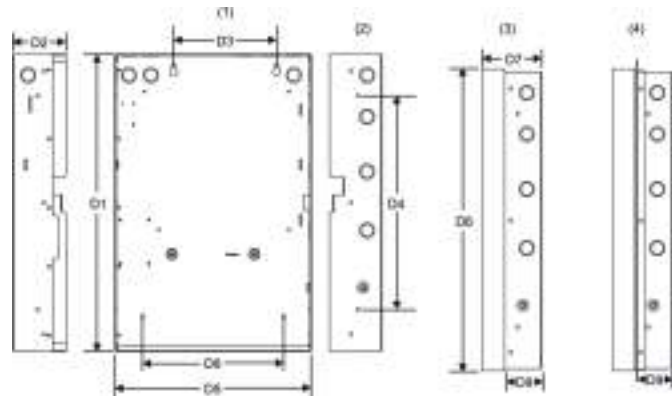

- (1) Surface Mounting Holes (3) Backbox with Door Attached  
 (2) Semi-flush Mounting Holes (4) Backbox with Door and Trim Kit attached

Panel dimensions, in (cm)									
Model	D1*	D2	D3	D4	D5*	D6	D7	D8	D9
iO1000	28.0 (71.1)	3.85 (9.8)	9.0 (22.8)	22.0 (55.8)	15.75 (40.0)	10.25 (26.0)	4.4 (11.1)	28.2 (71.6)	2.7 (6.8)
iO64	21.5 (54.6)	3.85 (9.8)	7.5 (19.0)	15.5 (39.4)	14.25 (36.2)	10.25 (26.0)	4.5 (11.4)	21.7 (55.1)	2.7 (6.8)

\* Add 1-1/2 in. (3.81 cm) to D1 and D5 dimensions for trim kit. The trim kit provides 0.75 inches (1.9 cm) of trim to the top, bottom, and sides of the backbox.

# System Layout

## iO1000

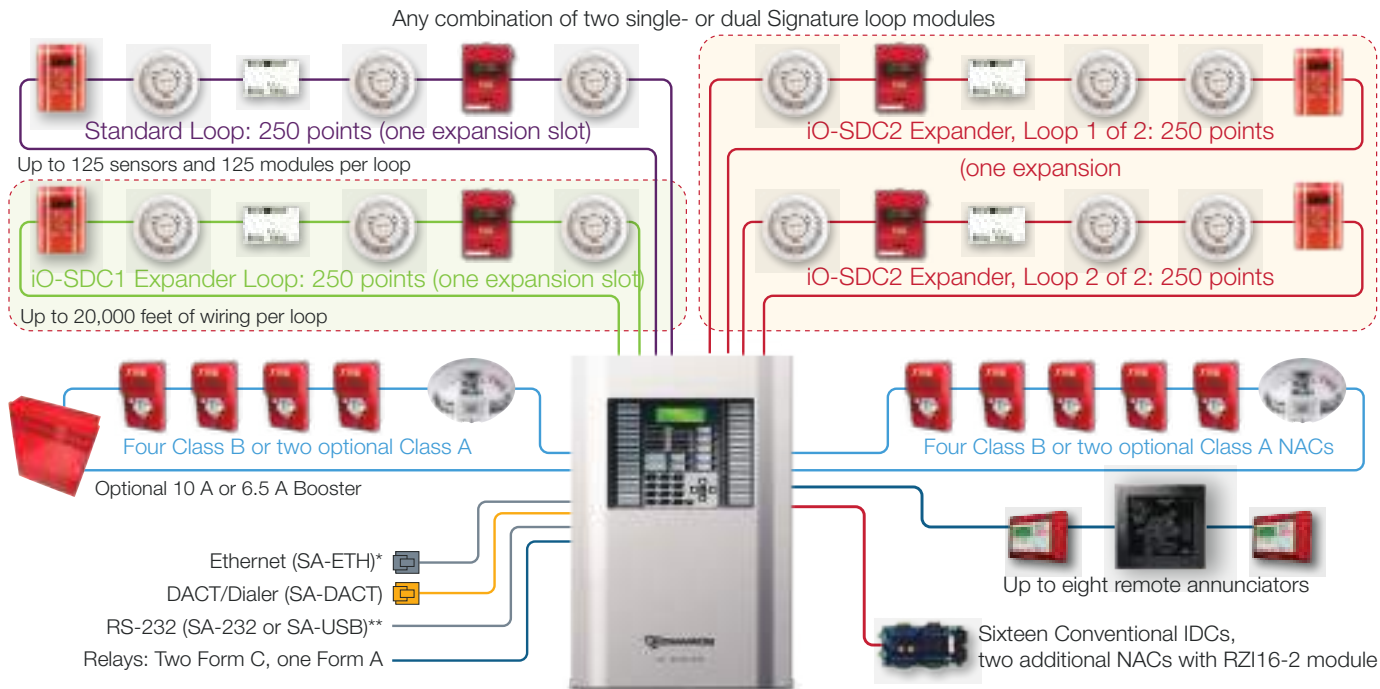

Each iO1000 panel has room for up to two Signature loop controller modules in any combination of single or dual 250-device loops. iO1000 loops support 125 detectors and 125 modules.

## Panel Layout

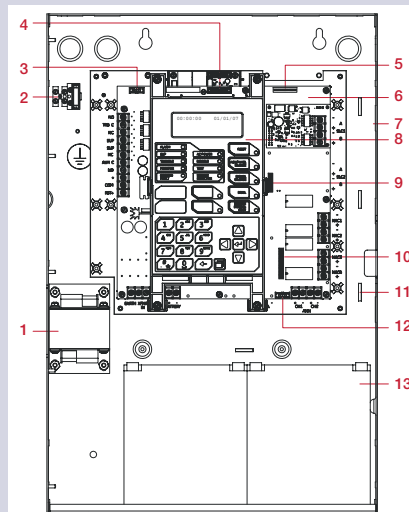

- 1 Transformer
- 2 Main AC wiring block & fuse holder
- 3 RS-232 card connector (J3)
- 4 Dialer card connection (J8)
- 5 Ethernet card connector (J1)
- 6 Main circuit board
- 7 Panel backbox enclosure
- 8 Operator interface
- 9 SLC card connector (J7)
- 10 Class A card connector (J2)
- 11 Tie wrap mounts
- 12 LED expander connector (J6)
- 13 Standby batteries

## iO64

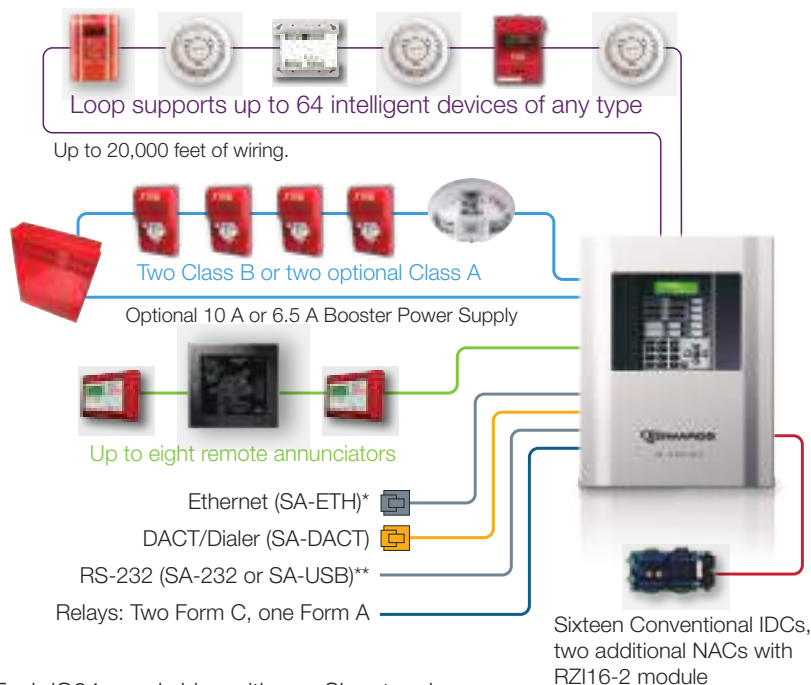

Each iO64 panel ships with one Signature loop controller that supports 64 devices of any type. This panel's device capacity cannot be expanded.

\*SA-ETH supports: (1) remote connectivity for diagnostics & programming, (2) Central station monitoring to Sur-Gard IP Receivers.

\*\*RS-232 supports: (1) Printer, (2) Programming Interface, (3) Use of Field Server Bridge (SA-FSB) for third-party Building Management Systems interface.

# Wiring & Configuration

## Signature device loop

The system provides one Signature device loop circuit with a total capacity of 125 detectors and 125 module addresses. The loop circuit is supervised for opens, shorts, and grounds.

Circuit specifications	iO1000	iO64
Device loops	One Class B or A loop, supporting 125 detectors and 125 modules. Expandable to four loops.	One Class B or A loop, supporting 64 devices of any kind.
Communication line voltage	Maximum 20 V peak-to-peak	
Circuit current	0.5 A max	
Circuit impedance	66Ω total, 0.5 μF, max	
Isolators	64 maximum	
Signal Synchronization	Supported on a system-wide basis (all device loops) when using a SIGA-CC1S or SIGA-MCC1S module and Genesis or Enhanced Integrity notification appliances.	

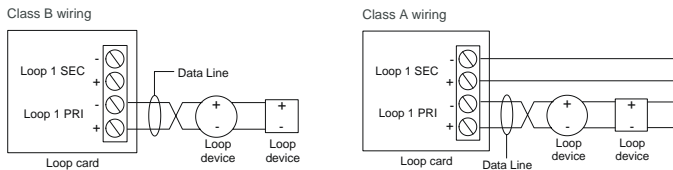

## Notification appliance circuits (TB2)

iO1000 control panels come equipped with four notification appliance circuits. iO64 control panels come with two NACs. Each circuit can be individually configured for continuous, temporal, synchronized, and coded output.

Specifications	iO1000	iO64
Circuit Type	4 Class B or 2 Class A	2 Class B or 2 Class A with SA-CLA module
Voltage	24 VFWR	
Current	6.0 A total, 2.5 A max. per circuit at 120/230 VAC 60 Hz. 5.0 A total, 2.5 A max. per circuit at 230 VAC 50 Hz.	3.75 A total, 2.5 A max. per circuit at 120/230 VAC 60 Hz. 3.0 A total, 2.5 A max. per circuit at 230 VAC 50 Hz.
Impedance	26 Ω total, 0.35 μF max	
EOLR	15 K Ω, ½ W	
Synchronization	Supported system-wide	

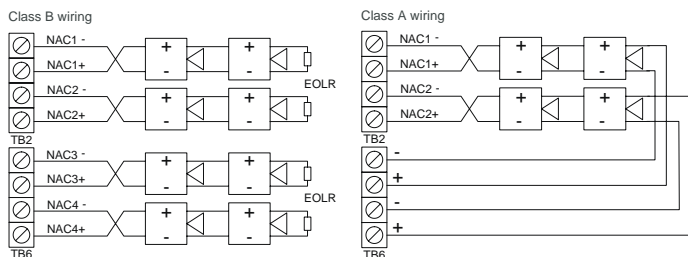

Marking indicates output signal polarity when the circuit is active. Polarity reverses when the circuit is not active. Wire notification appliances accordingly. Notification appliance polarity shown in active state.

## Auxiliary & smoke power outputs (TB3)

The control panel provides two auxiliary power outputs that can be used for powering ancillary equipment such as remote annunciators and two wire smoke detectors. Aux 2 can be software-selected to operate continuously. The circuit is supervised for shorts and grounds.

### Circuit specifications

Circuit voltage range	21.9 to 28.3 V
Resettable circuit (Aux power 2)	24 VDC nominal at 500 mA
Continuous circuit (Aux power 1)	24 VDC nominal at 500 mA. Use this circuit for powering two-wire smoke detectors.

Note: Any current above 0.5 amp connected to both Aux 1 and 2 will reduce the total available NAC power by that amount.

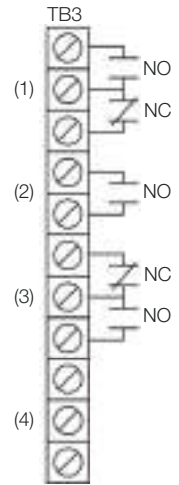

- (1) Trouble
- (2) Supervisory
- (3) Alarm
- (4) Smoke/Aux

## Alarm, trouble, and supervisory relay (TB3)

The trouble relay is normally-open, held closed, and opens on any trouble event or when the panel is de-energized. The supervisory relay is normally-open, and closes on any supervisory event. The alarm relay changes over on any alarm event.

### Relay specifications

	Alarm	Trouble	Supervisory
Type	Form C		Form A
Voltage	24 VDC at 1 A resistive		24 VDC at 1 A resistive

Relay circuits can only be connected to power-limited sources.

## Annunciator loop (TB4)

The control panel provides a connection for up to eight serially driven and supervised remote annunciators.

### Circuit specifications

Device loops	Class B (Style Y) or Class A (Style Z)
Circuit voltage	2.55 V
Circuit current	30 mA max
Circuit impedance	Up to 8 annunciators or 4000 feet

### Class B

### Class A

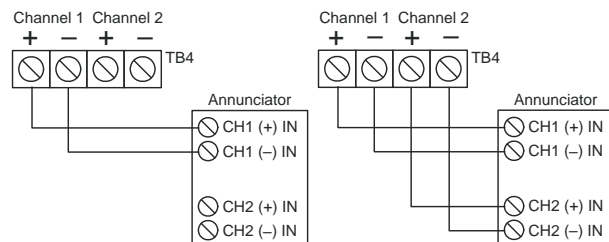



## Option Cards

EDWARDS brand iO Series panels are supported by a complete line of modules and related equipment that enhance performance and extend system capabilities. Option cards plug directly into the control panel main circuit board or are connected to it with a ribbon cable. After installation, terminals remain accessible. The cabinet provides ample room for wire routing, keeping wiring neat at all times.

### Single and Dual Loop Controller Cards

The iO-SDC1 is a single loop controller card that can be used with the iO64 as a replacement for the standard 64-point loop, or with the iO1000 as a 250-point expansion module.

The iO-SDC2 is a 500-point dual loop controller card for the iO1000 that provides two SLC circuits, each with 125 detector addresses and 125 module addresses.

Specifications	iO-SDC1	iO-SDC2
Device Addresses	iO1000: one loop, 250 device addresses iO64: 64 addresses	iO1000: two loops, 500 device addresses
Wiring	Class B or Class A	
Operating Voltage	24 VDC	
Operating Current (fully loaded loop)	Standby: 55 mA Alarm: 80 mA	Standby: 45 mA Alarm: 70 mA
Note: These ratings do not include the use of two-wire smoke modules.		
Communication Line Voltage	Max. 20.6 V peak-to-peak	
Terminal Rating	12 to 18 AWG (0.75 to 2.5 mm <sup>2</sup> )	
Circuit Current	0.5 A max.	
Max total loop resistance	66 Ω	
Max total loop capacitance	0.5 μF	
Isolators	64 isolators maximum per loop (total both isolator bases and modules)	
Ground Fault Impedance	0 to 5 kΩ	
Operating Environment	32 to 120°F (0 to 49°C) 0 to 93% noncondensing at 90°F (32°C)	

### SA-ETH Ethernet Interface Card/IP Communicator

The SA-ETH card provides a standard 10/100 Base T Ethernet network connection for connecting to an intranet, a local network, or the Internet. The card supports IP connectivity for monitoring services by a supervising station to meet NFPA 72 Chapter 26. The Ethernet card uses the FIBRO protocol to communicate with Sur-Gard System receivers (see below). The card can be used to download configuration programming from the iO-CU to the panel.



The Ethernet card is installed on the plastic assembly and connects to the main circuit board via a ribbon cable.

SA-ETH specifications	
Ethernet	10/100 Base-T
Operating environment	
Temperature	32 to 120°F (0 to 49°C)
Humidity	0 to 93% RH, noncondensing at 90°F (32°C)
Compatible Sur-Gard Receivers	SG-System I, II, III, IV and V

### RZI16-2 Remote Zone Interface Module



The RZI16-2 Addressable Remote Zone Interface Module is an addressable device that provides connections for sixteen Class B Initiating Device Circuits and two Class B Supervised Output Circuits. The inputs and outputs can be configured individually for several device types.

It requires 18 consecutive addresses on the Signaling Line Circuit (SLC). Addresses are assigned electronically. There are no address switches to set.

The RZI16-2 incorporates two 8-segment DIP switches that are used to select the Alarm or Supervisory default device type for each of the 16 IDC circuits. The module also includes one 4-segment DIP switch used to select the default Relay or NAC output device type. Device types other than the default are accomplished through programming.

#### RZI16-2 Specifications

Voltage	
24V/Aux nominal:	24 VDC
Supervisory current:	250 mA at 24 VDC nominal
Alarm Current	1000 mA
24V/Aux minimum:	18.4 VDC
24V/Aux maximum:	26.4 VDC
NAC1, NAC2 nominal:	24 VDC
Current	
Standby current for 4.7 k EOL (U.S.)	4.8 mA/ circuit
Standby current for 3.9 k EOL (Canada)	5.7 mA/ circuit
Alarm current at nominal voltage	31.1 mA/ circuit
Relay outputs	
Quantity	2
Type Rating (pilot duty)	Programmable 24 VDC at 2.5 A
Input circuit wiring resistance	25 Ω per wire
Initiating device circuits	
Quantity	16
EOL resistor	4.7 kΩ (U.S.); 3.9 kΩ Canada
Zone voltage	22.78 V for 4.7 kΩ (U.S.) 22.08 V for 3.9 kΩ (Canada)
Alarm current	31.1 mA/ channel at nominal voltage
Alarm impedance range	< 680 Ω
Trouble impedance range	> 5.55 kΩ
Supervised output circuits	
EOL resistor	15 kΩ
Quantity	2
Short circuit detection	< 2.6 kΩ
Open circuit detection	> 61.9 kΩ
Contact ratings	24 VDC at 2.5 A (5 A for two NACs)
Compatible cabinets	MFC-A, iO1000, APS

## SA-DACT Dialer

The SA-DACT provides communications between the control panel and the central station over a telephone line system. It transmits system status changes (events) to a compatible digital alarm communicator receiver over the public, switched telephone network. The dialer is capable of single, dual, or split reporting of events to two different account and telephone numbers. The modem feature of the SA-DACT can also be used for uploading and downloading panel configuration, history, and current status to a PC running the iO-CU.

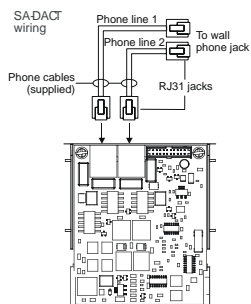

The dialer phone lines connect to connectors on the dialer's main circuit board. Phone line 1 connects to connector J4 and phone line 2 connects to connector J1.

The SA-DACT queues messages and transmits them based on priority (alarm, supervisory, trouble, and monitor). Activations are transmitted before restorations.

The SA-DACT is installed on the plastic assembly and connects to the main circuit board via a ribbon cable.

### SA-DACT specifications

Phone line type	One or two loop-start lines on a public, switched network
Phone line connector	RJ-31/38X (C31/38X)
Communication formats	Contact ID (SIA DC-05)
Operating environment	
Temperature	32 to 120°F (0 to 49°C)
Humidity	0 to 93% RH, noncondensing at 90°F (32°C)

### Compatible DACRs

Receiver	Models	Formats
Ademco	685	Contact ID
FBI	CP220	Contact ID
Osborne-Hoffman	OH 2000	Contact ID
Bosch	D6600	Contact ID
Silent Knight	9800	Contact ID
Sur-Gard	SG-MLR1, MLR2	Contact ID

## The SA-USB Interface Card

The SA-USB Interface Card provides a USB connection to a supported printer or a connection to a PC. The card can be used for connecting a printer to the control panel to print system events. The card can also be used for uploading and downloading panel configuration, history, and current status to a PC running the configuration utility (CU).

### SA-USB specifications

Operating voltage	24VDC
Current Standby/Alarm	13 mA, max 20mA
Universal Serial Bus (USB) ports	1 USB Type A – host port J3 (printer connection) 1 USB Type B – device port J4 (CU connection)
Supported Printer	PT-1S
Printer communication speed	9600 baud
Operating environment	
Temperature	32 to 120°F (0 to 49°C)
Humidity	0 to 93% RH, noncondensing

## SA-232 RS-232 interface

The SA-232 card provides an RS-232 interface with iO panels. It can be used for connecting a printer to the control panel to print system events. The card also can be used for connecting a computer to download a configuration program from the iO-CU to the control panel.

The RS-232 card is installed on the plastic assembly and connects to the main circuit board via a ribbon cable.



### SA-232 specifications

Operating voltage	Standard EIA-232
Terminal rating	12 to 18 AWG (0.75 to 2.5 sq mm)
Operating environment	
Temperature	32 to 120°F (0 to 49°C)
Humidity	0 to 93% RH, noncondensing at 90°F (32°C)

## SA-CLA Class A Module (iO64 only)

The SA-CLA card provides Class A capability for NAC wiring. Its terminal block provides the wiring connection for NAC return wiring. The card is required for annunciator Class A wiring even though this wiring does not return to the SA-CLA card. The SA-CLA is compatible with iO64 control panels only. iO1000 panels are Class A Ready. The SA-CLA is installed directly to the control panel circuit board using its plastic standoffs and plug connection.

### SA-CLA specifications

Operating voltage	24 VFWR
Operating current	3.75 A FWR total at 120/230 VAC 60 Hz 3.0 A FWR total at 230 VAC 50 Hz 2.5 A max per circuit
Circuit impedance	26 ohms, 0.35uF
Terminal rating	12 to 18 AWG (0.75 to 2.5 sq mm)
Operating environment	
Temperature	32 to 120°F (0 to 49°C)
Humidity	0 to 93% RH, noncondensing at 90°F (32°C)

## D16L-iO LED Display Expander (iO1000 only)

The D16L-iO LED Display Expanders provide LED annunciation for up to 16 zones. It provides two LEDs for each zone. Two D16L-iO LED display expanders can be installed in each iO1000 panel.

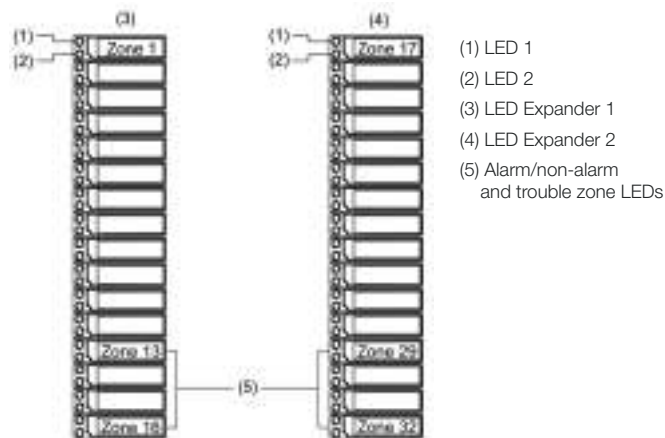

# Specifications

	<b>iO64</b>	<b>iO1000</b>
Device loops	1 loop Class B or Class A (Styles 4, 6, 7) supporting up to 64 device addresses (any combination of detectors and modules)  Maximum T-taps: 63 (each device can be on its own branch)	1 loop, expandable to 4, Class A or B (Styles 4, 6, 7), each loop supporting up to 250 device addresses (125 detectors and 125 modules max.). Addresses 1 to 125 are for detectors and addresses 126 to 250 are for modules  Maximum T-taps/loop: 124
Notification appliance circuits	2 Class B (Style Y), Class A (Style Z) optional  3.75 A FWR total at 120/230 VAC 60 Hz  3.0 A FWR total at 230 VAC 50 Hz  2.5 A FWR each max. per circuit	4 Class B (Style Y) or 2 Class A (Style Z)  6.0 A FWR total at 120/230 VAC 60 Hz  5.0 A FWR total at 230 VAC 50 Hz  2.5 A FWR each max. per circuit
Primary power	120 VAC, 60 Hz, 1.3 A max.  230 VAC, 50-60 Hz, 0.62 A max.	120 VAC, 60 Hz, 2.0 A max.  230 VAC, 50-60 Hz, 0.97 A max.
Base panel current standby	155 mA	172 mA
Base panel current alarm	204 mA	267 mA
Input zones	16 max.	32 max.
Remote annunciator	8 drops max., RS-485 Class B, Class A is optional  Data line length: 4,000 ft. (1,219 m)	8 drops max., RS-485 Class A or B  Data line length: 4,000 ft. (1,219 m)
Operating voltage	24 VDC panel	
Auxiliary power output circuit	Aux power 1: 500 mA, 24 VDC (1 A possible if you reduce total available NAC power by 500 mA)  Aux power 2: 500 mA, 24 VDC  Output: 28.3 to 21.9 VDC, special application  <i>Note: For a list of compatible devices, see the iO64 and iO1000 Series Compatibility List (P/N 3102353-EN)</i>	
Loop circuit	Maximum loop resistance: 66 $\Omega$  Maximum loop capacitance: 0.5 $\mu$ F  Communication line voltage: Maximum 20.6 V peak-to-peak  Operating current (fully loaded loop) Stand by: 55 mA/45 mA  Alarm: 125 mA/115 mA (not including two-wire smoke modules)  Circuit current: 0.5 A max. Style 4, 6, and 7 wiring  Max. resistance between isolators: Limited only by overall wire run lengths  64 isolators maximum per loop (total both isolator bases and modules)	
Batteries	Type: Sealed lead acid  Voltage: 24 VDC  Charging current: 2.47 A max. Amp hour capacity: 26 Ah  Standby operation: 24 hour or 60 hour  Placement: Up to two 10 Ah batteries will fit in the iO64 control panel cabinet and two 18 Ah batteries will fit in the iO1000 control panel cabinet. If larger batteries are required, use an EDWARDS battery cabinet.	
SA-DACT dialer	Phone line type: One or two loop-start lines on a public, switched network  Phone line connector: RJ-31/38X (C31/38X)  Communication formats: Contact ID (SIA DC-05)  Operating current Standby/Alarm: 41 mA Max.: 100 mA  FCC registration number: GESAL01BSADACT  Industry Canada Registration number: 3944A-SADACT  Ringer equivalence number: 0.1B	
Ground fault impedance	0 to 5 k $\Omega$	
Alarm contact	Form C N.O. 24 VDC at 1 A (resistive load)	
Trouble contact	Form C 24 VDC at 1 A (resistive load)	
Supervisory contact	Form A N.O. 24 VDC at 1 A (resistive load)	
Environmental	Temperature: 0 to 49°C (32 to 120°F) Relative humidity: 0 to 93% noncondensing	
Terminal rating	All terminals rated for 12 to 18 AWG (0.75 to 2.5 mm <sup>2</sup> )	



LIFE SAFETY & INCIDENT MANAGEMENT

**Contact us**

Phone: 800-655-4497 (Option 4)  
 Email: [edwards.fire@carrier.com](mailto:edwards.fire@carrier.com)  
 Website: [edwardsfiresafety.com](http://edwardsfiresafety.com)

8985 Town Center Pkwy  
 Bradenton, FL 34202

©2023 Carrier  
 All Rights Reserved.

## Ordering Information

Part	Description
------	-------------

### iO1000 Fire Alarm Systems

IO1000G	Four loop system with one 250-point loop installed. 110v, gray door.
IO1000G-2	Four loop system with one 250-point loop installed. 230v, gray door.
IO1000G-2-PG	Four loop system with one 250-point loop installed. 230v, gray door, Portuguese.
IO1000G-2-SP	Four loop system with one 250-point loop installed. 230v, gray door, Spanish.
IO1000G-CA	Four loop system, one 250-point loop installed. 110v, gray door, LED strips, Canada.
IO1000G-F	Four loop system, one 250-point loop. 110v, gray door, LED strips, French Canada.
IO1000G-PG	Four loop system with one 250-point loop installed. 110v, gray door, Portuguese.
IO1000G-SP	Four loop system with one 250-point loop installed. 110v, gray door, Spanish.
IO1000R	Four loop system with one 250-point loop installed. 110v, red door.
IO1000R-2	Four loop system with one 250-point loop installed. 230v, red door.
SA-TRIM2	iO1000 Flush mount trim, black.

### iO64 Fire Alarm Systems

IO64G	One loop system with one 64-point loop installed. 110v, gray door.
IO64G-2	One loop system with one 64-point loop installed. 230v, gray door.
IO64G-2-PG	One loop system with one 64-point loop installed. 230v, gray door, Portuguese.
IO64G-2-SP	One loop system with one 64-point loop installed. 230v, gray door, Spanish.
IO64GL	One loop system, one 64-point loop installed. 110v, gray door, English Canada.
IO64GL-F	One loop system, one 64-point loop installed. 110v, gray door, French Canada.
IO64G-PG	One loop system with one 64-point loop installed. 110v, gray door, Portuguese.
IO64G-SP	One loop system with one 64-point loop installed. 110v, gray door, Spanish.
IO64R	One loop system with one 64-point loop installed. 110v, red door.
IO64R-2	One loop system with one 64-point loop installed. 230v, red door.
SA-TRIM1	iO64 Flush mount trim, black

### Option Cards

iO-SDC1	Expansion module, one 250-device loop.
iO-SDC2	Expansion module, two 250-device loops, 500 devices total. For iO1000 only.
RZ116-2	Remote Zone Interface Module. 16 Class B IDCs, 2 Class B Output. Includes bracket.
SA-DACT	Dual Line Dialer/Modem, supports Contact ID, mounts in cabinet on base plate.
SA-232	RS-232 Serial Port for connection to printers & computers, mounts in cabinet.
SA-ETH	Ethernet Port, IP Communicator, mounts in cabinet on base plate.
SA-CLA	Class A adapter module. Provides Class A capacity on NACs. Mounts in cabinet on main board. iO64 systems only.
SA-FSB	Field Server Bridge for connection to 3rd Party Building Management Systems. Supports BACnet and Modbus protocols. Mounts in the MFCA cabinet using the FSB-BRKT2 mounting plate. See separate SA-FSB datasheet E85010-0156 for additional information.
SA-USB	RS-232 Serial port for connection to printers & computers, mounts in cabinet.
D16L-iO-2	LED Annunciator module, 16 X 2-LED zones (4 programmable for sup). Mounts in cabinet to right of LCD display for zones 17-32. For iO1000 only.
D16L-iO-1	LED Annunciator module, 16 X 2-LED zones (4 programmable for sup). Mounts in cabinet to left of LCD display for zones 1-16. For iO1000 only.
D8RY-iO-2	Canada only: LED Annunciator module, two LEDs per zone, 16 zones (4 alarm only, 8 supervisory only, 4 alarm or supervisory). Mounts in cabinet. For iO1000 only.
D8RY-iO-1	Canada only: LED Annunciator module, two LEDs per zone, 16 zones (4 alarm only, 8 supervisory only, 4 alarm or supervisory). Mounts in cabinet. For iO1000 only.

### Accessories

CTM	City Tie Module. 2-gang. Connection to a local energy fire alarm box.
MFC-A	Multifunction Fire Cabinet, 8" x 14" x 3.5" - red.
SIGA-REL	Releasing Module
PT-1S	System Printer
BC-1	Battery Cabinet. 14.0" x 18.25" x 7.25". Holds two 12V24A batteries.
BC-1R	Battery Cabinet - Red. 14.0" x 18.25" x 7.25". Holds two 12V24A batteries.
BC-1EQ	Seismic hardening Kit for iO series panels. Includes battery hardening for BC-1 enclosure and components to harden panel internal components.

### Programming Tools

iO-CU	IO Series configuration and diagnostics utility.
260097	RS232 cable, 4 conductor, DB9 PC interface